

TRANSPORTNI  
**VALJCI**

• [www.tehnoguma-zg.hr](http://www.tehnoguma-zg.hr)

**G**TEHNOGUMA

# TRANSPORTNI VALJCI

## TEHNIČKI OPIS

Valjci se odlikuju sigurnim pogonom, malim otporom u radu, dugim vijekom trajanja i visokim stupnjem iskorištenja. Namijenjeni su ugradbi na transportere s trakom, teške kotrljače i slične sustave transporta i vođenja. Kućište je oblikovano u hladnom stanju iz čeličnog lima i završno obrađeno prema **ISO M7**. Kućišta su zavarena na plašt i centrirana prema osi tako da čine čvrstu cjelinu. Osovina je izrađena od čelika, radna površina obrađena je prema standardu **ISO h6**. Ulazak vode i prljavštine je spriječen pomoću:

- brtvenog poklopca
- podmazane zatvorene predkomore
- višestrukoga labirintnog brtvila s uskim rasporima izrađena od posebne plastike

Tim sustavom brtvljenja ujedno je riješen i problem trajanja podmazivanja. Gumirane valjke izvodimo navlačenjem gumenih prstenova na osnovni valjak ili gumiranjem gumom u pločama prema potrebama kupca.

## TECHNICAL DESCRIPTION



They feature safe operation, small resistance, long service life and a high degree of utilization. They are designed for installation on belt conveyors, heavy-duty roller trains and similar conveyors and steering systems. The end cap is cold formed steel sheet and finished to **ISO M7** standards. The roller end-caps are welded to the shell and aligned to the axis for stability. The shaft is made of steel, with operating surfaces ground to **ISO h6** standards. Water and dirt are prevented from entering the bearing by:

- sealing cap
- a large grease-filled prechamber with a locking plate
- a multiply labyrinth packing with narrow slits made of a special plastic

The system of sealing solves simultaneously the problem of lubrication. We perform rubber coating by putting on rubber rings on the main roller of rubber lining rubber in plates, according to customer needs.

## TECHNISCHE BESCHREIBUNG



Die Walzen zeichnen sich mit einem sicheren Betrieb, geringem Widerstand, langer Lebensdauer und einem hohen Wirkungsgrad aus. Sie sind für die Montage in Förderbändern, schwere Walzenlaufwerke und ähnliche Transportsysteme bestimmt. Das Gehäuse ist aus Stahlblech in kaltem Zustand geformt und nach **ISO M7** Endbearbeitet. Die Gehäuse sind auf einen Mantel geschweißt und zur Achse zentriert, um somit eine feste Einheit zu bilden. Die Achse ist aus Stahl gefertigt, die Oberfläche ist nach dem **ISO h6** bearbeitet. Das Eindringen von Wasser und Schmutz ist verhindert durch:

- verschlusskappe
- geschlossene gefettete Vorkammer
- multiple Labyrinth Dichtungen mit mehreren Spalten gefertigt aus Spezialkunststoff

Mit diesem Dichtungssystem ist auch das Problem der Schmierzeit gelöst. Die Gummiwalzen werden durch das aufziehen von Gummiringen auf die Basiswalzen oder durch Gummitüllen mit Gummiplatten, nach Bedarf des Kunden, gefertigt.

## TIPOVI VALJAKA | TYPES OF IDLERS | WALZENTYPE

## OSNOVNI VALJCI | BASIC ROLLERS | BASIS WALZEN

[www.tehnoguma-zg.hr](http://www.tehnoguma-zg.hr)

TIP / TYPE	D	a	b	d	SW
OV 60-20	60				
OV 89-20	89				
OV 108-20	108	4	9	20	14-15
OV 133-20	133				
OV 159-20	159				
OV 89-25	89				
OV 108-25	108	4	12	25	18
OV 133-25	133				
OV 159-25	159				
OV 89-30	89				
OV 108-30	108	4	12	30	22
OV 133-30	133				
OV 159-30	159				

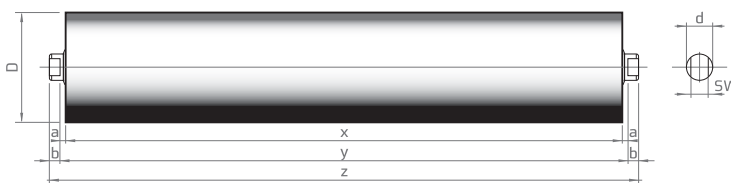

**Primjer oznake:** OV valjak tip OV 89-20; x=315; SW 14 / standardne dužine (x) mm valjaka: / **For example:** OV roller type OV 89-20; x=315; SW 14 / standard length (x) mm valjaka:  
**Walzen bezeichnung:** OV Walze Type OV 89-20; x=315; SW 14 / standard Längen (x) mm der Walzen:

**160, 200, 250 315, 380, 465, 550, 600, 750, 900, 1000, 1150, 1400, 1600**

TIP VALJAK S DISKOVIMA - PVD / IDLERS WITH DISKS - PVD / TYPE - WALZE MIT SCHEIBEN PVD

TIP / TYPE	De	D	a	b	d	SW
PVD 89-60	89					
PVD 110-60-20	110					
PVD 120-60-20	120	60	4	9	20	14-15
PVD 133-60-20	133					
PVD 133-89-20	133	89	4	9	20	14-15
PVD 133-89-25	133					
PVD 159-89-25	159	89	4	12	25	18

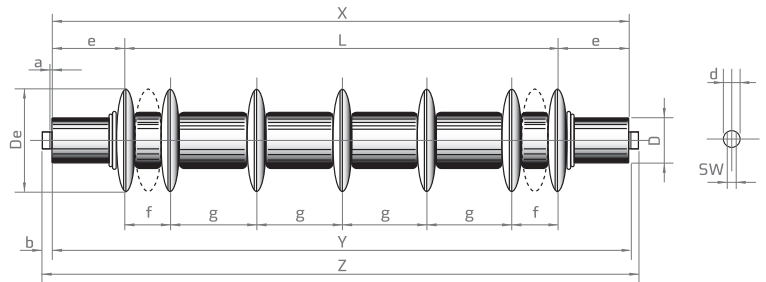

TIP / TYPE	De	D	h
GD 89-60	89	60	80
GD 110-60	110	60	30
GD 120-60	120	60	30
GD 133-60	133	60	30
GD 133-89	133	89	30
GD 159-89	159	89	30

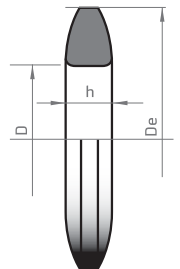

Primjer oznake: disk GD 108 - 60

For example: disc GD 108 - 60 / Kennzeichnung: Scheibe GD 108-60

Valjci s gumenim diskovima pomažu otklanjanju materijala koji se zalijepio na traku čime se sprječava bočno zanošenje. Na velikim postrojenjima trake trebaju biti gušće poduprte na rubovima što se postiže dodavanjem gumenih diskova na kraju valjka. Nehabajući gumeni diskovi smješteni su na valjcima, čeličnim prstenima i učvršćeni na krajevima sa zaustavnim prstenima. Na zahtjev možemo isporučiti valjke s diskovima smještenim na razmacima drukčijim od onih na slici.

 Irregular swellings of sticky materials carried develop on the surface of normal idlers, causing large skids of the belt. The idlers with rubber disk avoid this defect. In big plants often the belt must be more supported at the edges, and this is possible adding a further rubber disk to those placed at both ends by stoping rings. On request we can supply idlers with disks spaced at distances different from those of the drawings.

 Walzen mit Gummischeiben helfen beim Reinigen des verklebten Materiales am Förderband wodurch ein seitliches Abweichen verhindert wird. Bei großen Anlagen müssen die Transportbänder dichter gestützt werden; dies ist durch den Einsatz von Gummischeiben an beiden Enden der Walze möglich. Die abriebfesten Gummischeiben sind mit Stahlringen an den Walzenenden mit Stopp Ringen befestigt. Auf Wunsch, können die Walzen mit anderen Abständen als gezeigt in der Abbildung, geliefert werden.

POVRATNI VALJAK S GUMENIM SPIRALNIM PRSTENIMA TIP PVS | SELF CLEANING IDLERS |  
RÜCKFÜHRWALZE MIT SPIRALFÖRMIGEN GUMMISCHEIBEN PVS

GUMENI SPIRALNI VALJCI PVS / RUBBER SPIRAL IDLERS / TYPE-SPIRALFÖRMIGE GUMMIWALZEN PVS

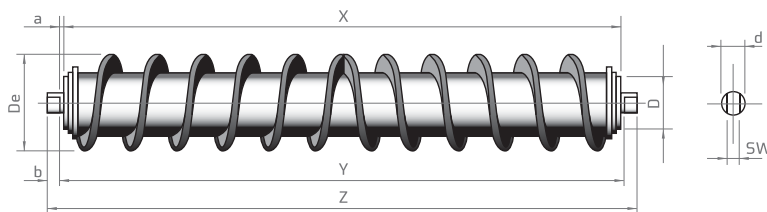

TIP / TYPE	De	D	a	b	d	SW
PVS 133-60-20	133	60	4	9	20	14-15
PVS 159-89-25	159	89	4	12	25	18

Gumeni spiralni valjak ima iste funkcije kao i valjci s diskovima uz pojačanu ulogu čišćenja i centriranja trake. Gumeni prsteni s lijevim i desnim spiralama smješteni su na valjku i pričvršćeni na njihovim krajevima zaustavnim prstenima. Učinak vijka, prouzročen rotacijom valjka, potiskuje materijal bočno i osigurava čišćenje trake.

 The rubber spiral idlers have the same function as the idlers with discs, and also they keep the belt clean and in line. Two antiabrasive rubber sleeves with left and right spiral are fitted on the idler and fixed at the ends by stop rings. The screw effect, caused by the idler rotation, expels the material sideways assure the belt cleasing. Moreover the spiral motion helps to keep the belt in line.

 Spiralförmige Gummiwalzen haben die gleiche Aufgabe wie die Rückführwalzen mit der zusätzlichen Funktion des Reinigens und der Zentrierung des Förderbandes. Gummiringe mit linken und rechten Spiralen sind auf der Walze angebracht und an den Enden mit Stoppringen befestigt. Die Auswirkung der Schraube, verursacht durch die Rotation, drückt das Material seitlich aus und sorgt für die Reinigung des Transportbandes.

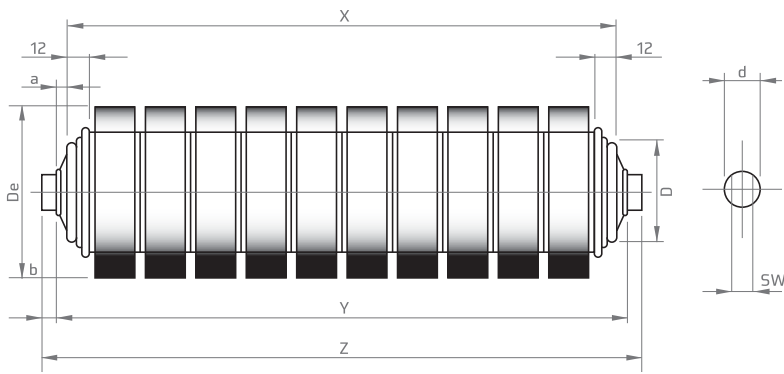

## AMORTIZACIJSKI VALJCI AV / IMPACT IDLERS AV / AMORTISATIONSWALZEN AV

Valjci s amortizacijskim prstenima koriste se za ublažavanje pada materijala i izbjegavanja oštećenja na traci. Otporni na udarce i abraziju, gumeni prsteni učvršćeni su na valjcima i fiksirani na krajevima sa završnim prstenima. Manjom širinom prstena dobivena je manja dodirna površina s trakom radi manjeg trošenja. Rezervni prsteni su dostupni na upit.

 The idlers with impact rings are used to deaden the fall of material avoiding belt damages. The shockproof and abrasionproof rubber rings are keyed on the idlers and fixed at the ends with stop rings. The small width of rings allows to obtain a larger surface with the belt for less wear of the same. Spare rings are available on request.

 Walzen mit Amortisationsringen werden zum dämpfen des Materialturzes und um Transportbänderbeschädigungen zu verhindern. Sie sind auf Schläge und Abrasion beständig. Die Gummiringe sind auf den Walzen befestigt und an den Enden mit Endringen fixiert. Mit einer kleineren Ringbreite ist eine kleinere Kontaktfläche mit dem Band gegeben, Ersatz-Ringe sind auf Anfrage erhältlich.

TIP / TYPE	De	D	a	b	d	SW
AV 89-60-20	89	60				
AV 108-60-20	108	60	4	9	20	14-15
AV 133-89-20	133	89				
AV 133-89-25	133	89				
AV 133-89-25	159	89	4	12	25	18
AV 133-89-30	133	89				
AV 159-89-30	159	89	4	12	30	22

**Primjer oznake:** AV valjak tip AV 108 - 60 - 20: X = 315; SW 14

**For example:** AV roller type AV 108 - 60 - 20: X = 315; SW 14

**Kennzeichnung:** AV Walze Type AV 108 - 60 - 20: X = 315; SW 14

TIP / TYPE	De	D	h	h1
AP 89-60	89	60	25	20
AP 108-60	108	60	35	30
AP 133-89	133	89	35	30
AP 159-89	150	89	35	30

**Primjer oznake:** AP 89-60

**For example:** AP 89-60 / **Kennzeichnung:** Ring AP 108-60

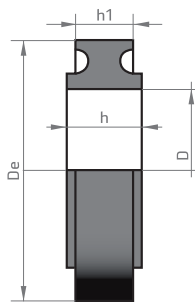

## PRIJEDLOG STANDARDNIH ZAVRŠETAKA VALJAKA | PROPOSED STANDARD TYPES OF ENDINGS | VORGESCHLAGENE STANDARD WALZEN

www.tehnoguma-zg.hr

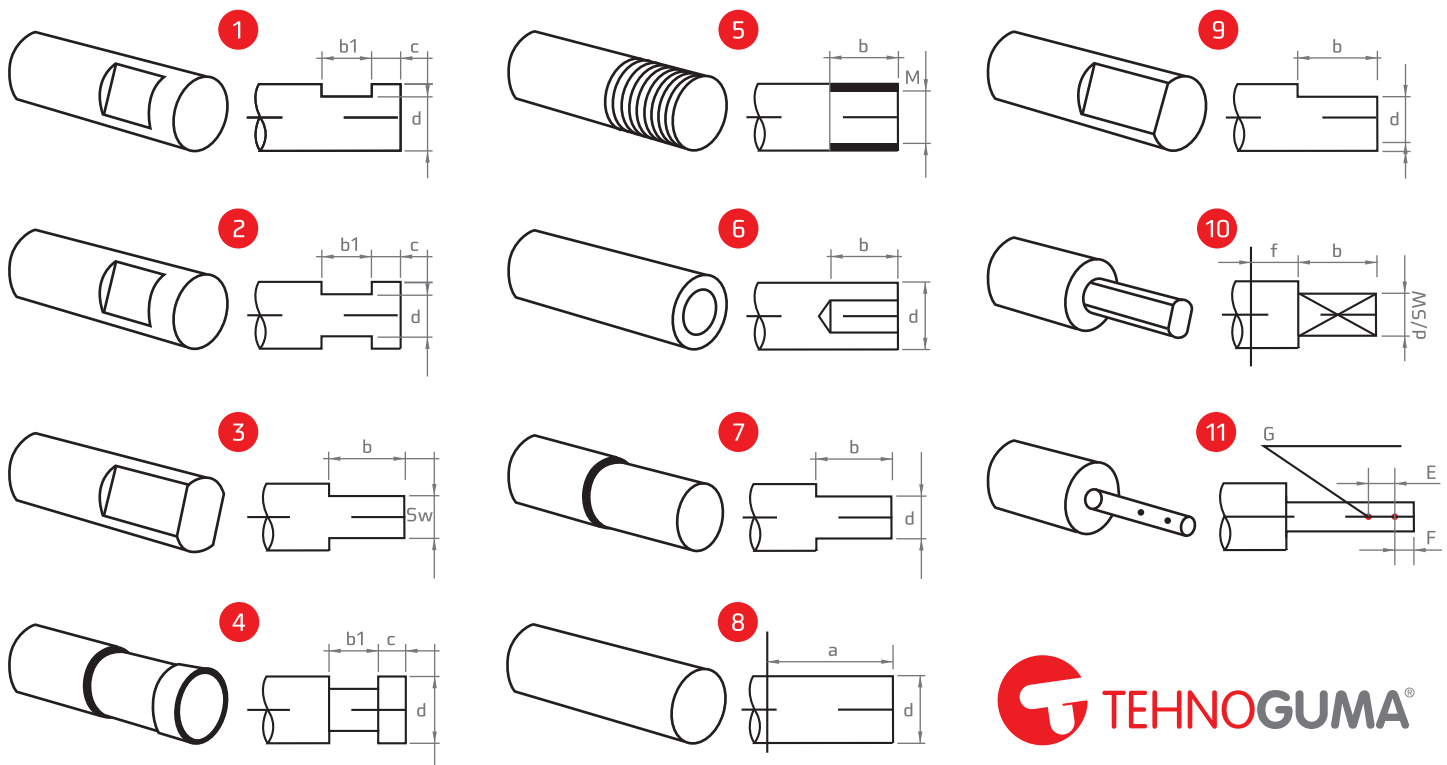

**Za narudžbe je potrebno navesti:**

tip, promjer i duljinu valjka, promjer izlazne osovine i broj komada.

Npr:

OV Ø89x250 (Ø20), SW=14, 100 komada

**In your order kindly specify:**

the type, diameter and lengths of roller, shaft diameter and quantity.

For example:

OV Ø89x250 (Ø20), SW=14, 100 pieces

**Für die Bestellung sind folgende Daten anzugeben:**

Type, Durchmesser und Länge der Walzen, Durchmesser der Ausgangsachse und die Stückzahl.

Zum Beispiel:

OV Ø89x250 (Ø20), SW=14, 100 Stk.





 **TEHNOGUMA**<sup>®</sup> d.o.o.  
[www.tehnoguma-zg.hr](http://www.tehnoguma-zg.hr)

• 10 000 ZAGREB, CMP Savica Šanci, Obrtnička 1  
T: +385 (0)1 2406 242, F: +385 (0)1 2499 525  
E: [tehnoguma@tehnoguma-zg.hr](mailto:tehnoguma@tehnoguma-zg.hr)

• 21 000 SPLIT, Solinska 56  
T: +385 (0)21 772 150, F: +385 (0)21 656 134,  
E: [split@tehnoguma-zg.hr](mailto:split@tehnoguma-zg.hr)

 **TGSTIL**<sup>®</sup> d.o.o.

Prodaja, ugradnja i održavanje podnih obloga  
[info@tgstil.hr](mailto:info@tgstil.hr), [www.tgstil.com.hr](http://www.tgstil.com.hr)

 **TGArt**<sup>®</sup> d.o.o.

Prodaja pločastih materijala, lasersko rezanje i graviranje  
[tgart@tgart.hr](mailto:tgart@tgart.hr), [www.tgart.hr](http://www.tgart.hr)

 **NAUTICLINE**<sup>d.o.o.</sup>

Proizvodnja i prodaja nautičke opreme  
[nauticline1@nauticline.hr](mailto:nauticline1@nauticline.hr), [www.nauticline.hr](http://www.nauticline.hr)